



Student Name: _____

Teacher's Name: _____

KNOX GRAMMAR SCHOOL

2014

Trial Higher School Certificate Examination

Mathematics General 2

General Instructions

- Reading time – 5 minutes
- Working time – 2.5 hours

- Write using blue or black pen only
- Board approved calculators only
- Draw diagrams in pencil
- A formulae sheet and multiple choice answer sheet are provided

Subject teachers

Ms E Ruff
Mr L Harvey *
Mrs L Dempsey
Mr S Cheah
Ms S Yun/Mrs Knight
Mrs C Ward
Ms M Lindaya

Total Marks - 100

Section I Pages 2 - 12

25 marks

- Attempt questions 1 - 25
- Allow 35 minutes for this section

Section II Pages 13 - 31

75 marks

- Attempt questions 26 - 30
- Allow about 1 hour and 55 minutes for this section

This paper MUST NOT be removed from the examination room

Number of Students in Course: 138

MC	Q26	Q27	Q28	Q29	Q30	TOTAL
/25	/15	/15	/15	/15	/15	/100

Section I

25 marks

Attempt Questions 1-25

Allow about 35 minutes for this section

Use the multiple-choice answer sheet for Questions 1 – 25

1. An enterprise agreement has the following annual salary arrangements:

Daniel's employer pays 6% more than the enterprise agreement. He is on Step 3 and receives an allowance for Leader 2.

<i>Base Salary</i>	<i>Leadership Allowance</i>
Step 1 \$35 000	Leader 1 \$5000
Step 2 \$40 000	Leader 2 \$7500
Step 3 \$45 000	Leader 3 \$10 000

What is Daniel's gross monthly salary?

- (A) \$4375.00
 - (B) \$4412.50
 - (C) \$4600.00
 - (D) \$4637.50
2. Jack borrowed \$11 000. He repaid the loan in full at the end of two years with a lump sum of \$12 000.

What annual simple interest rate was he charged?

- (A) 4.17%
- (B) 4.55%
- (C) 8.33%
- (D) 9.09%

3. A square pyramid fits exactly on top of a cube to form a solid.

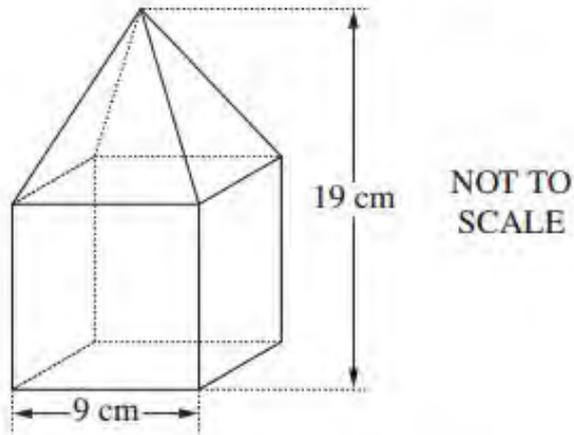

What is the volume of the solid?

- (A) 513 cm^3
- (B) 999 cm^3
- (C) 1242 cm^3
- (D) 1539 cm^3
4. The shaded region shows a quadrant with a rectangle removed.

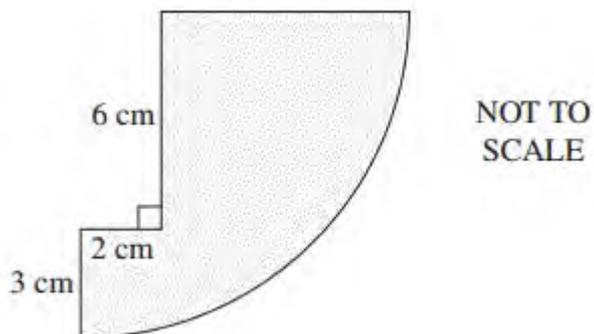

What is the area of the shaded region, to the nearest cm^2 ?

- (A) 38 cm^2
- (B) 52 cm^2
- (C) 61 cm^2
- (D) 70 cm^2

5. George wants to build a rectangular vegetable garden in his back yard. He has 20 metres of fencing and will use a wall as one side of the garden. The plan of his garden is shown, where x metres is the width of his garden.

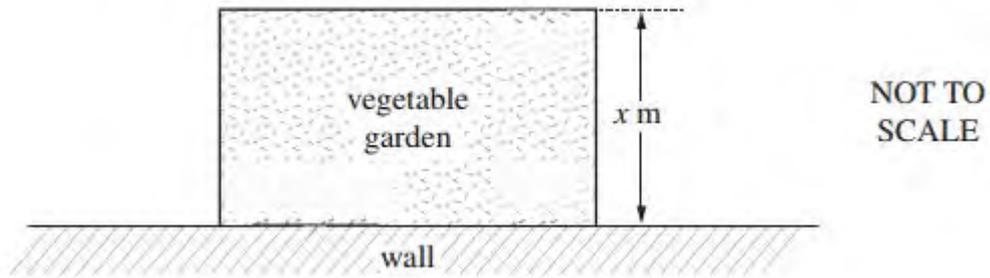

Which equation gives the area, A , of the vegetable garden?

- (A) $A = 10x - x^2$
- (B) $A = 10x - 2x^2$
- (C) $A = 20x - x^2$
- (D) $A = 20x - 2x^2$
6. What is the value of θ , to the nearest degree?

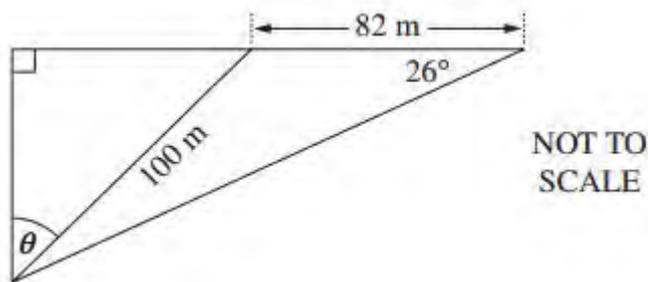

- (A) 21°
- (B) 32°
- (C) 43°
- (D) 55°

7. A plane flies on a bearing of 30° from A to B ?

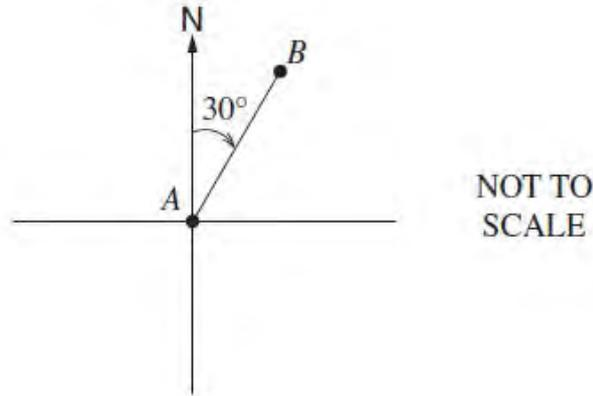

What is the bearing of A from B ?

- (A) 030°
(B) 150°
(C) 210°
(D) 330°
8. An entertainment system was purchased for \$2100 on 12 April 2014 using a credit card. Simple interest was charged at a rate of 19.74% per annum for purchases using the credit card. No other purchases were made and there was no interest-free period. The period for which interest was charged included the date of purchase and the date of payment.
- What amount was required to pay the account in full on 20 May 2014?
- (A) \$2143.16
(B) \$2143.59
(C) \$2144.29
(D) \$2144.74
9. Jordan bought a new car for \$45 000. In the first year the value of the car depreciated by 25%. In the second and third years the value depreciated by 10% per year.
- What is the value of the car at the end of the third year, to the nearest dollar?
- (A) \$17 663
(B) \$24 750
(C) \$27 000
(D) \$27 338

10. The equally spaced cross-sectional area of a water reservoir are shown.

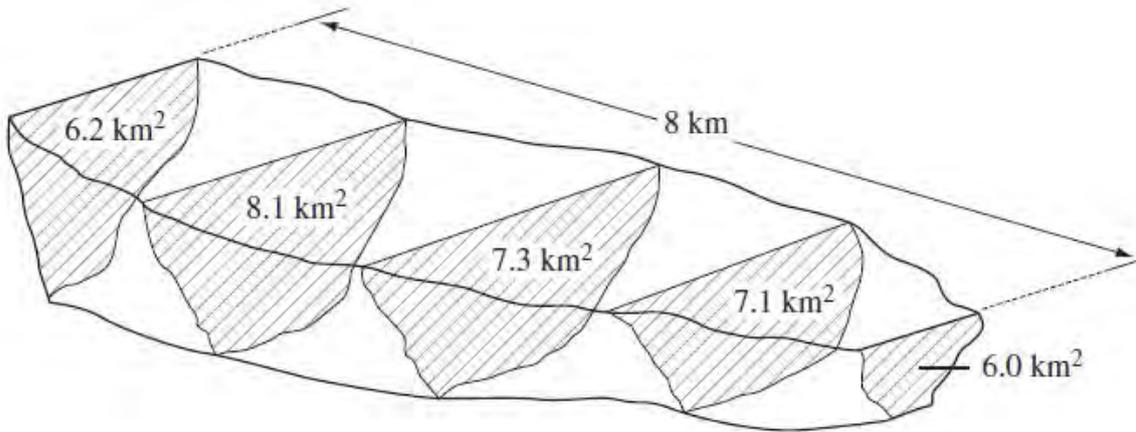

Using Simpson's rule twice, what is the approximate volume of the reservoir?

- (A) 31 km³
 (B) 58 km³
 (C) 117 km³
 (D) 234 km³
11. Consider the data displayed in the stem-and-leaf plot below which shows the number of gold medals won by a country at each Olympic Games.

Stem Leaf	Key 1 5 = 15
0 0 1 3 5 5 8	
1 0 0 2 3 7 7 8	
2 0 1	

At the next Olympic Games the country wins 12 gold medals. When this is added to the data set:

- (A) The median will decrease and the interquartile range will decrease.
 (B) The median will decrease and the interquartile range will increase.
 (C) The median will increase and the interquartile range will remain the same.
 (D) The median will increase and the interquartile range will increase.

12. Max’s phone has an 8 GB memory. He wants to download some apps that have an average size of 95 MB. The number of apps that Max is able to store on his phone is:
- (A) 11
 - (B) 84
 - (C) 86
 - (D) 87

13. Benji is being trained as a drug sniffer dog to be used at the airport. To test Benji, 200 pieces of luggage are placed on a baggage carousel and drugs are placed in a small number of these. The results of Benji’s test are shown in the two-way table below.

	Drugs detected	Drugs not detected	Total
Bags with drugs inside	23	2	25
Bags without drugs inside	19	156	175
Total	42	158	200

To be used as a drug sniffer dog, Benji must meet two criteria:

Criterion 1: The dog must have a minimum 90% success rate in detecting bags that have drugs inside

Criterion 2: The dog cannot have more than 15% ‘false positives’ ie saying drugs are in the luggage when in fact they are not.

Based on these criteria, which of the following statements is correct?

- (A) Benji passes both criteria.
- (B) Benji passes criterion 1 but fails criterion 2.
- (C) Benji fails criterion 1 but passes criterion 2.
- (D) Benji fails on both criteria.

14. David has bought his first car for \$4000. David does not think it is worth insuring the car but wants protection against damage to other people and property that he may be responsible for.
- David will need to take out:
- (A) compulsory third party insurance
 - (B) third party property insurance
 - (C) comprehensive insurance
 - (D) both A and B
15. A rock is thrown from the top of a 20-metre cliff. The height above the ground level after t seconds can be given by the equation $h = 20 + 15t - 5t^2$. The rock will hit the ground after:
- (A) 2 seconds
 - (B) 3 seconds
 - (C) 4 seconds
 - (D) 5 seconds
16. The wattage on a toaster is 1750 W. The toaster is used for an average of 3 minutes per day. Given that electricity costs 25.1c/kWh, calculate the cost of running the toaster for a year.
- (A) \$4.58
 - (B) \$8.01
 - (C) 43.92
 - (D) \$127.24
17. The profit made by a concert is given by the formula $P = 15N - 2000$, where P is the profit made and N is the number of people who attend the concert.
- The profit will increase by how much if an extra 200 people attend the concert?
- (A) \$200
 - (B) \$1000
 - (C) \$3000
 - (D) \$5000

18. John and Mackenzie are on a fitness program for one month. The probability that John will finish the program successfully is 0.7, while the probability that Mackenzie will finish it is 0.6. The probability tree diagram shows this information.

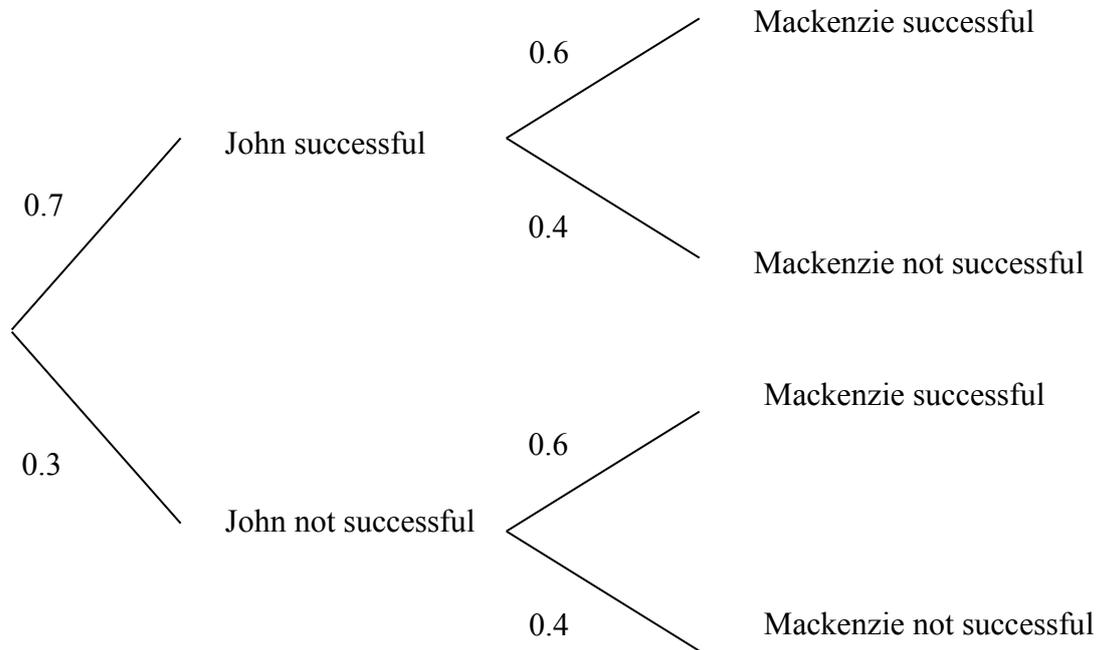

What is the probability that only one of John and Mackenzie will be successful?

- (A) 0.18
 - (B) 0.28
 - (C) 0.42
 - (D) 0.46
19. A triangular pyramid and a triangular prism are of equal height, and have bases that are equal in area. Which of the following statements is *correct*?
- (A) The triangular prism has three times the volume of the triangular pyramid.
 - (B) The triangular prism has one-third the volume of the triangular pyramid.
 - (C) Both the triangular pyramid and prism have the same volume
 - (D) You cannot work out which has the greater volume without knowing the area of the bases and the heights.

20. Walter wants to invest money into an annuity for 5 years. He will invest \$1000 per year. Walter can invest the money at 8% p.a. with interest compounded quarterly, so he decides to make his contribution in four equal payments.

Use the table below to calculate the future value of Walter's annuity

Future value of \$1												
Period	Interest rate per period											
	1%	2%	3%	4%	5%	6%	7%	8%	9%	10%	11%	12%
1	1.0000	1.0000	1.0000	1.0000	1.0000	1.0000	1.0000	1.0000	1.0000	1.0000	1.0000	1.0000
2	2.0100	2.0200	2.0300	2.0400	2.0500	2.0600	2.0700	2.0800	2.0900	2.1000	2.1100	2.1200
3	3.0301	3.0604	3.0909	3.1216	3.1525	3.1836	3.2149	3.2464	3.2781	3.3100	3.3421	3.3744
4	4.0604	4.1216	4.1836	4.2465	4.3101	4.3746	4.4399	4.5061	4.5731	4.6410	4.7097	4.7793
5	5.1010	5.2040	5.3091	5.4163	5.5256	5.6371	5.7507	5.8666	5.9847	6.1051	6.2278	6.3528
6	6.1520	6.3081	6.4684	6.6330	6.8019	6.9753	7.1533	7.3359	7.5233	7.7156	7.9129	8.1152
7	7.2135	7.4343	7.6625	7.8983	8.1420	8.3938	8.6540	8.9228	9.2004	9.4872	9.7833	10.0890
8	8.2857	8.5830	8.8923	9.2142	9.5491	9.8975	10.2598	10.6366	11.0285	11.4359	11.8594	12.2997
9	9.3685	9.7546	10.1591	10.5828	11.0266	11.4913	11.9780	12.4876	13.0210	13.5795	14.1640	14.7757
10	10.4622	10.9497	11.4639	12.0061	12.5779	13.1808	13.8164	14.4866	15.1929	15.9374	16.7220	17.5487
11	11.5668	12.1687	12.8078	13.4864	14.2068	14.9716	15.7836	16.6455	17.5603	18.5312	19.5614	20.6546
12	12.6825	13.4121	14.1920	15.0258	15.9171	16.8699	17.8885	18.9771	20.1407	21.3843	22.7132	24.1331
13	13.8093	14.6803	15.6178	16.6268	17.7130	18.8821	20.1406	21.4953	22.9534	24.5227	26.2116	28.0291
14	14.9474	15.9739	17.0863	18.2919	19.5986	21.0151	22.5505	24.2149	26.0192	27.9750	30.0949	32.3926
15	16.0969	17.2934	18.5989	20.0236	21.5786	23.2760	25.1290	27.1521	29.3609	31.7725	34.4054	37.2797
16	17.2579	18.6393	20.1569	21.8245	23.6575	25.6725	27.8881	30.3243	33.0034	35.9497	39.1899	42.7533
17	18.4304	20.0121	21.7616	23.6975	25.8404	28.2129	30.8402	33.7502	36.9737	40.5447	44.5008	48.8837
18	19.6147	21.4123	23.4144	25.6454	28.1324	30.9057	33.9990	37.4502	41.3013	45.5992	50.3959	55.7497
19	20.8109	22.8406	25.1169	27.6712	30.5390	33.7600	37.3790	41.4463	46.0185	51.1591	56.9395	63.4397
20	22.0190	24.2974	26.8704	29.7781	33.0660	36.7856	40.9955	45.7620	51.1601	57.2750	64.2028	72.0524

- (A) \$5866.60
- (B) \$6074.35
- (C) \$9549.10
- (D) \$24 297.40

21. Angus has a holiday job painting identification labels on parking areas in a shopping complex. Each label uses one of the letters A, B, C, D and E and one of the digits 6, 7, 8 and 9 and he paints the codes in either red or blue.

How many different parking area labels can Angus paint?

- (A) 11
- (B) 20
- (C) 40
- (D) 90

22.

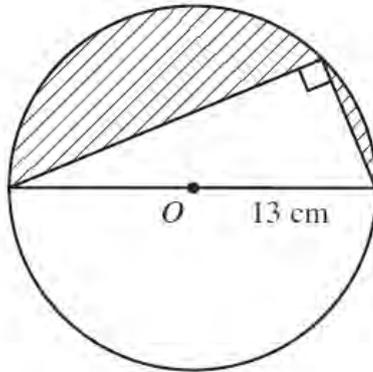

The centre of a circle is O and the radius is 13 cm. One side of the triangle is 10 cm long. Calculate the size of the shaded area correct to 1 decimal place.

- (A) 145.5 cm^2
 - (B) 223.9 cm^2
 - (C) 410.9 cm^2
 - (D) 941.9 cm^2
23. Lake Baikal in Siberia is one of the coldest places on Earth. Its typical winter temperature is -76° F . Use the formula $F = \frac{9}{5}C + 32$, where C = degrees Celsius and F = degrees Fahrenheit, to determine the typical winter temperature at Lake Baikal in degrees Celsius.
- (A) -24.4° C
 - (B) -60° C
 - (C) -104.8° C
 - (D) -194.4° C

24. The table below shows Elijah's results in four subjects. The mean and standard deviation for each subject are also shown.

Subject	Elijah's Mark	Mean	Standard Deviation
English	70	60	7.5
Maths	72	60	10
Chemistry	71	63	4
Biology	68	58	8

In which subject did Elijah achieve his best standardised result?

- (A) English
- (B) Maths
- (C) Chemistry
- (D) Biology

25.

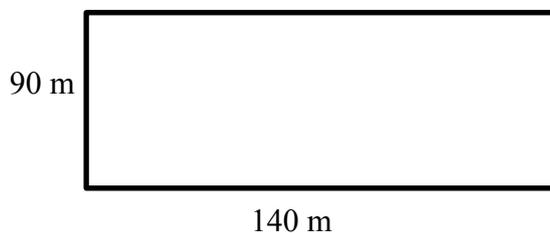

The diagram above shows the dimensions of a playing field. The lengths are given correct to the nearest 10 metres.

What is the maximum possible area of the playing field?

- (A) 12 600 m²
- (B) 12 715.25 m²
- (C) 13 775 m²
- (D) 15 000 m²

End of Section I

Section II

75 marks

Attempt Questions 26 – 30

Allow about 1 hour and 55 minutes for this section

Answer all questions in the spaces provided.

Your responses should include relevant mathematical reasoning and/or calculations

Extra writing space is provided on page 32. If you use this space, clearly indicate which question you are answering.

QUESTION 26 (15 marks) Answer the questions in the spaces provided

- (a) Sebastian weighs 80 kilograms. He has consumed 5 standard drinks in 2 hours. Calculate his blood alcohol level (*BAC*), correct to 2 significant figures.

2

- (b) Timothy created this box and whisker plot from data that he had collected.

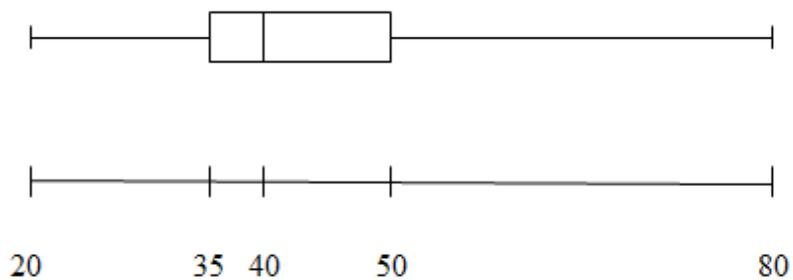

He said that the highest score was an outlier.

Is Timothy correct? Justify your answer with appropriate calculations.

2

Question 26 continued on page 14

Question 26 continued

- (c) The diagram show triangle ABE similar to triangle ACD in which $AE = x$, $ED = 2x$, $BE = 8$ cm and BE is parallel to CD .

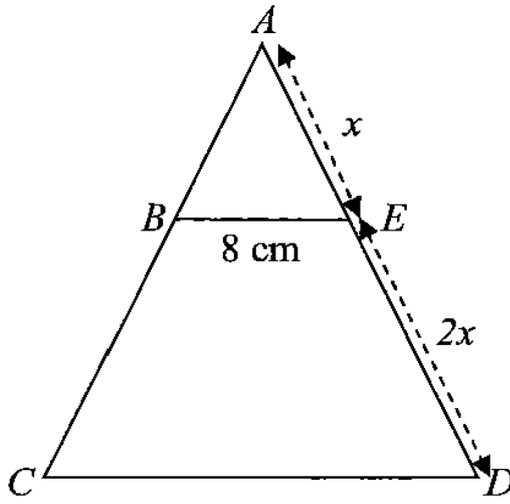

NOT TO SCALE

- (i) What is the ratio of enlargement from triangle ABE to triangle ACD ? **1**

.....

.....

.....

- (ii) What is the length of CD ? **1**

.....

.....

.....

.....

- (iii) If $AD = 36$ cm, what is the length of ED ? **1**

.....

.....

.....

.....

.....

Question 26 continued

(d) According to Dominic’s mobile phone plan, he is offered 2 gigabytes (GB) of data usage. After one year the phone company offers Dominic a 15% increase in his data usage, and after two years they offer him a further 10% increase in his usage.

(i) What is the overall percentage increase in Dominic’s data usage after two years?

.....

.....

.....

.....

.....

.....

.....

3

(ii) The original amount of data usage was calculated as 2.00 GB, correct to two decimal places. What is the percentage error in this calculation?

.....

.....

.....

.....

.....

.....

.....

.....

2

Question 26 continued on page 16

Question 27 continued

(a) (ii) The probability that a baby bellbird will survive to become an adult is 0.62. There are two baby bellbirds in a nest. What is the probability that

(1) they both survive to become adults? **1**

(2) only one survives to become an adult? **2**

(3) at least one of the will survive to become an adult? **2**

Question 27 continued on page 19

Question 28 continued

- (c) When David's compass is near an electrical current, the needle points east of magnetic north at an angle θ .

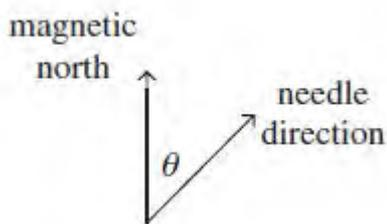

The size of θ is inversely proportional to the cube of the distance, x metres, between the compass and the electrical current.

- (i) Explain why the formula

$$\theta = \frac{k}{x^3}$$

represents the relationship between θ and x .

1

- (ii) When David's compass is 1.5 m from the electrical current, the size of θ is 5° . Determine the size of θ when $x = 50$ cm.

2

Question 28 continued on page 23

QUESTION 29 (15 marks) Answer the questions in the spaces provided.

(a) The graph shows the tax payable against income, in thousands of dollars.

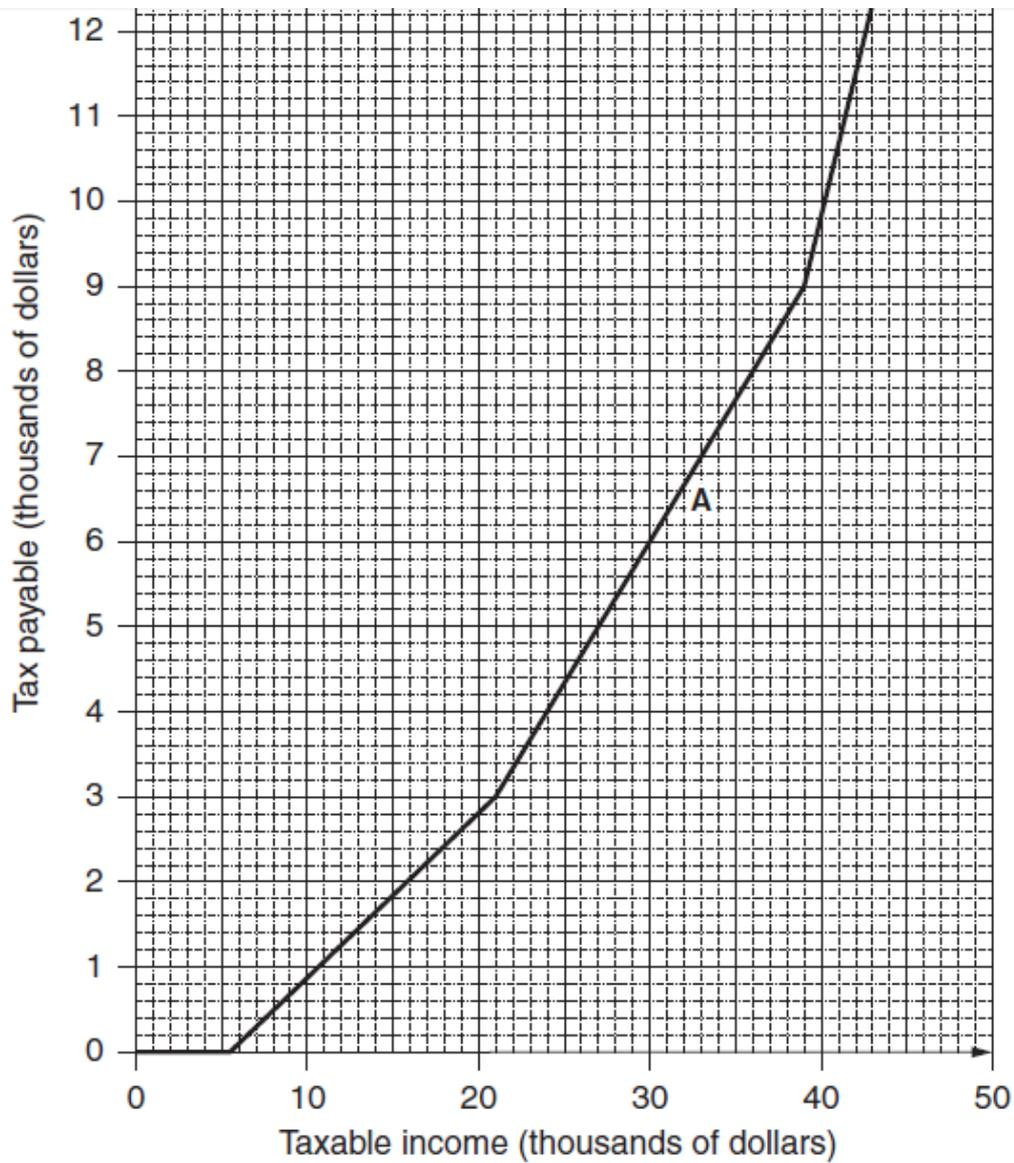

(i) Using the graph, find the tax payable on a taxable income of \$21 000. **1**

.....

(ii) Find the gradient of the section of the graph marked **A**. **1**

.....

.....

.....

.....

Question 29 continued on page 25

Question 29 continued

- (iii) For taxable income between \$21 00 and \$39 000, how much of each dollar is payable in tax. **1**

- (iv) Write an equation that could be used to calculate the tax payable T , in terms of the taxable income I , for taxable incomes between \$21 000 and \$39 000. **2**

Question 29 continued on page 26

Question 29 continued

- (b) The area (A) of a rectangular yard with a length of x metres is given by the formula: $A = 30x(15 - x)$ where A is in square metres. The graph of A against different values of x is shown below.

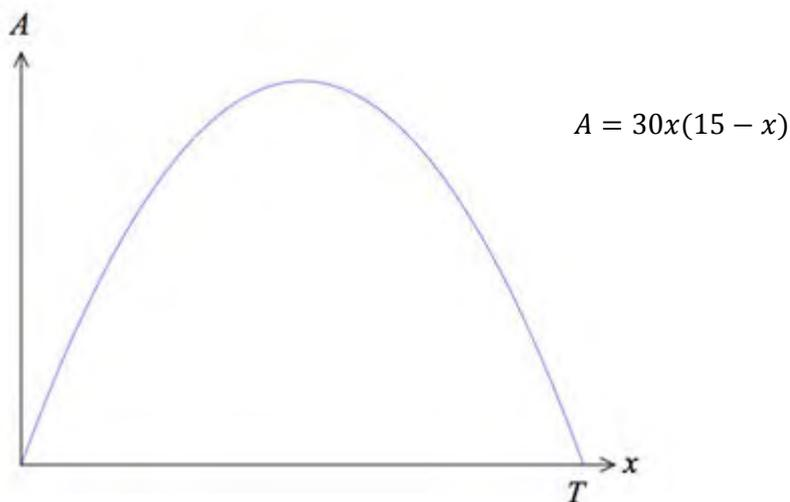

- (i) Complete the following table of values.

2

x	0	5	10	15
A				

- (ii) What is the value of T on the graph?

1

.....

.....

- (iii) Calculate the maximum area of the yard

2

.....

.....

.....

.....

Question 29 continued on page 27

Question 29 continued

(c) The time in Sydney is 10 hours ahead of the time in London. A jet leaves Sydney on Friday 8am and flies directly to London. The flight takes 22 hours.

(i) Calculate the time in London when the jet arrives? **2**

.....

.....

.....

.....

(ii) If the distance between Sydney and London is 17 000 km, calculate the average speed of the jet in kilometres per hour. Give your answer to the nearest whole number. **1**

.....

.....

.....

.....

(iii) The plane starts the flight with 184 tonnes of fuel, and on landing had enough fuel in reserve to fly another 45 minutes. How much fuel was used for the flight? Give your answer correct to the nearest tonne. **2**

.....

.....

.....

.....

.....

.....

.....

.....

.....

End of Question 29

QUESTION 30 (15 marks) Answer the questions in the spaces provided.

- (a) A game is designed using a spinner as shown in the diagram. Each game consists of one spin and the arrow points to the winning colour.

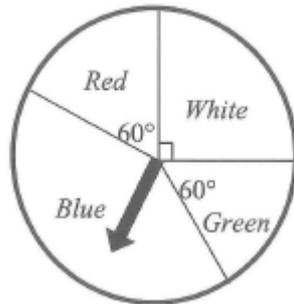

- (i) In any single game, what is the probability that the winning colour is blue? **2**

.....

.....

.....

.....

.....

- (ii) If the arrow finishes on white, the player wins \$6. If it lands on red or green the player wins \$10. The player loses \$13 if the result of the spin is blue.

Calculate the financial expectation of one game. **2**

.....

.....

.....

.....

.....

.....

.....

.....

.....

Question 30 continued on page 29

Question 30 continued

- (b) The table shows present value interest factors for some monthly interest rates (r) and loan terms in months (N)

Table of present value interest factors						
r	0.0060	0.0065	0.0070	0.0075	0.0080	0.0085
N						
45	39.33406	38.90738	38.48712	38.07318	37.66545	37.26383
46	40.09350	39.64965	39.21263	38.78231	38.35859	37.94133
47	40.84841	40.38714	39.93310	39.48617	39.04622	38.61311
48	41.59882	41.11986	40.64856	40.18478	39.72839	39.27924
49	42.34475	41.84785	41.35905	40.87820	40.40515	39.93975
50	43.08623	42.57113	42.06459	41.56645	41.07653	40.59470

Mark borrows \$10 000 for a car. He arranges to repay the loan with monthly repayments over 4 years. He is charged 7.2% per annum interest.

Using the table above, calculate the amount of interest Mark will pay over the term of this loan. **3**

.....

.....

.....

.....

.....

.....

.....

.....

.....

.....

Question 30 continued on page 30

Question 30 continued

(c) The table shows a student's score on a game console and their pulse rate.

Game console (x)	5	7	18	20	30	43	50	58	60	65
Pulse rate (y)	97	93	85	77	75	64	70	64	60	55

(i) Draw a scatterplot and a line of best fit.

2

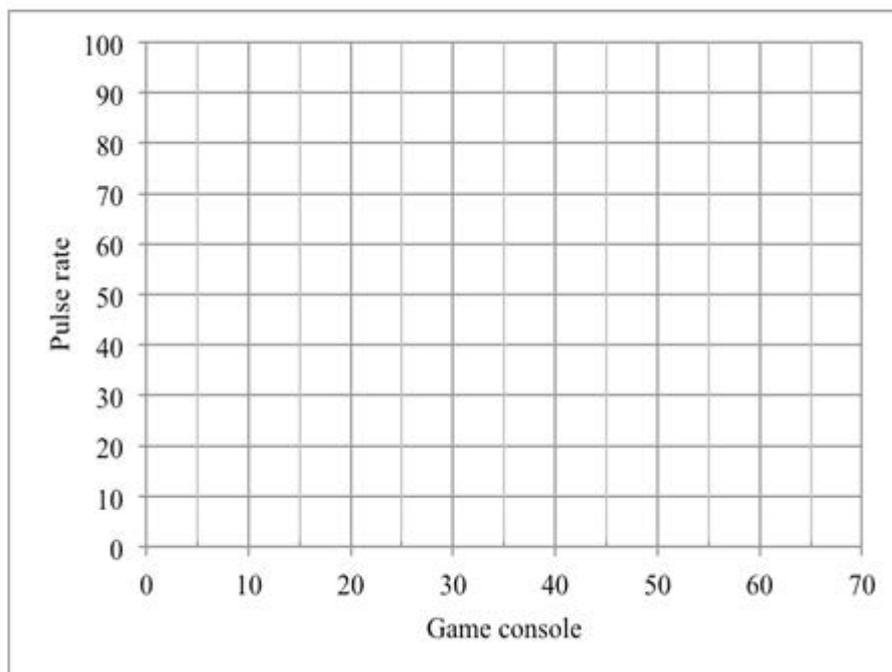

(ii) Determine an equation for the line of best fit.

2

.....

.....

.....

.....

.....

(iii) Calculate the value of the correlation coefficient. Answer correct to 2 decimal places.

1

.....

.....

.....

.....

Question 30 continued on page 31



Student Name: SOLUTIONS

Teacher's Name: _____

KNOX GRAMMAR SCHOOL

2014

Trial Higher School Certificate Examination

Mathematics General 2

General Instructions

- Reading time – 5 minutes
- Working time – 2.5 hours

- Write using blue or black pen only
- Board approved calculators only
- Draw diagrams in pencil
- A formulae sheet and multiple choice answer sheet are provided

Subject teachers

Ms E Ruff
Mr L Harvey *
Mrs L Dempsey
Mr S Cheah
Ms S Yun/Mrs Knight
Mrs C Ward
Ms M Lindaya

Total Marks - 100

Section I Pages 2 - 12

25 marks

- Attempt questions 1 - 25
- Allow 35 minutes for this section

Section II Pages 13 - 31

75 marks

- Attempt questions 26 - 30
- Allow about 1 hour and 55 minutes for this section

This paper MUST NOT be removed from the examination room

Number of Students in Course: 138

MC	Q26	Q27	Q28	Q29	Q30	TOTAL
/25	/15	/15	/15	/15	/15	/100

KNOX TRIAL HSC MATHEMATICS GENERAL 2 MULTIPLE CHOICE ANSWER SHEET 2014

NAME : _____

- | | | | | |
|-----|------------------------------------|------------------------------------|------------------------------------|------------------------------------|
| 11. | A <input type="radio"/> | B <input type="radio"/> | C <input checked="" type="radio"/> | D <input type="radio"/> |
| 12. | A <input type="radio"/> | B <input type="radio"/> | C <input checked="" type="radio"/> | D <input type="radio"/> |
| 13. | A <input checked="" type="radio"/> | B <input type="radio"/> | C <input type="radio"/> | D <input type="radio"/> |
| 14. | A <input type="radio"/> | B <input type="radio"/> | C <input type="radio"/> | D <input checked="" type="radio"/> |
| 15. | A <input type="radio"/> | B <input type="radio"/> | C <input checked="" type="radio"/> | D <input type="radio"/> |
| 16. | A <input type="radio"/> | B <input checked="" type="radio"/> | C <input type="radio"/> | D <input type="radio"/> |
| 17. | A <input type="radio"/> | B <input type="radio"/> | C <input checked="" type="radio"/> | D <input type="radio"/> |
| 18. | A <input type="radio"/> | B <input type="radio"/> | C <input type="radio"/> | D <input checked="" type="radio"/> |
| 19. | A <input checked="" type="radio"/> | B <input type="radio"/> | C <input type="radio"/> | D <input type="radio"/> |
| 20. | A <input type="radio"/> | B <input checked="" type="radio"/> | C <input type="radio"/> | D <input type="radio"/> |
| 21. | A <input type="radio"/> | B <input type="radio"/> | C <input checked="" type="radio"/> | D <input type="radio"/> |
| 22. | A <input checked="" type="radio"/> | B <input type="radio"/> | C <input type="radio"/> | D <input type="radio"/> |
| 23. | A <input type="radio"/> | B <input checked="" type="radio"/> | C <input type="radio"/> | D <input type="radio"/> |
| 24. | A <input type="radio"/> | B <input type="radio"/> | C <input checked="" type="radio"/> | D <input type="radio"/> |
| 25. | A <input type="radio"/> | B <input type="radio"/> | C <input checked="" type="radio"/> | D <input type="radio"/> |

- | | | | | |
|-----|-------------------------|------------------------------------|------------------------------------|------------------------------------|
| 1. | A <input type="radio"/> | B <input type="radio"/> | C <input type="radio"/> | D <input checked="" type="radio"/> |
| 2. | A <input type="radio"/> | B <input checked="" type="radio"/> | C <input type="radio"/> | D <input type="radio"/> |
| 3. | A <input type="radio"/> | B <input checked="" type="radio"/> | C <input type="radio"/> | D <input type="radio"/> |
| 4. | A <input type="radio"/> | B <input checked="" type="radio"/> | C <input type="radio"/> | D <input type="radio"/> |
| 5. | A <input type="radio"/> | B <input type="radio"/> | C <input type="radio"/> | D <input checked="" type="radio"/> |
| 6. | A <input type="radio"/> | B <input type="radio"/> | C <input checked="" type="radio"/> | D <input type="radio"/> |
| 7. | A <input type="radio"/> | B <input type="radio"/> | C <input checked="" type="radio"/> | D <input type="radio"/> |
| 8. | A <input type="radio"/> | B <input type="radio"/> | C <input checked="" type="radio"/> | D <input type="radio"/> |
| 9. | A <input type="radio"/> | B <input type="radio"/> | C <input type="radio"/> | D <input checked="" type="radio"/> |
| 10. | A <input type="radio"/> | B <input checked="" type="radio"/> | C <input type="radio"/> | D <input type="radio"/> |

Section I

25 marks

Attempt Questions 1-25

Allow about 35 minutes for this section

Use the multiple-choice answer sheet for Questions 1 – 25

1. An enterprise agreement has the following annual salary arrangements:

Daniel's employer pays 6% more than the enterprise agreement. He is on Step 3 and receives an allowance for Leader 2.

Base Salary		Leadership Allowance	
Step 1	\$35 000	Leader 1	\$5000
Step 2	\$40 000	Leader 2	\$7500
Step 3	\$45 000	Leader 3	\$10 000

What is Daniel's gross monthly salary?

(A) \$4375.00

(B) \$4412.50

(C) \$4600.00

(D) \$4637.50

$$\frac{(45000 + 7500) \times 1.06}{12} = \$4637.50$$

2. Jack borrowed \$11 000. He repaid the loan in full at the end of two years with a lump sum of \$12 000.

What annual simple interest rate was he charged?

(A) 4.17%

(B) 4.55%

(C) 8.33%

(D) 9.09%

$$I = Prn$$
$$1000 = 11000 \times r \times 2$$
$$r = \frac{1000}{11000 \times 2}$$
$$= 0.04545$$
$$\text{rate} = 4.55\%$$

3. A square pyramid fits exactly on top of a cube to form a solid.

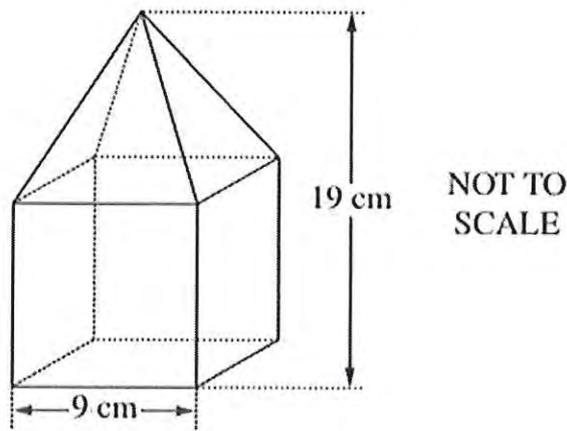

What is the volume of the solid?

- (A) 513 cm³
- (B) 999 cm³
- (C) 1242 cm³
- (D) 1539 cm³

$$V = 9^3 + \frac{1}{3} \times 9^2 \times 10 = 999 \text{ cm}^3$$

4. The shaded region shows a quadrant with a rectangle removed.

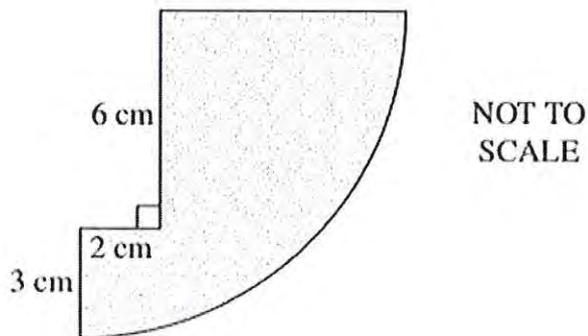

What is the area of the shaded region, to the nearest cm²?

- (A) 38 cm²
- (B) 52 cm²
- (C) 61 cm²
- (D) 70 cm²

$$A = \frac{1}{4} \times \pi \times 6^2 - 6 \times 2 = 51.617$$

5. George wants to build a rectangular vegetable garden in his back yard. He has 20 metres of fencing and will use a wall as one side of the garden. The plan of his garden is shown, where x metres is the width of his garden.

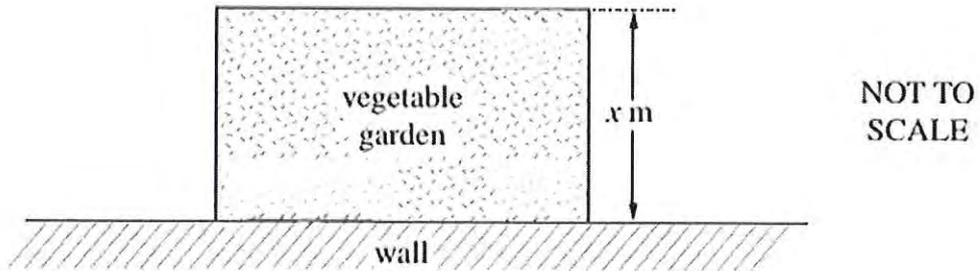

Which equation gives the area, A , of the vegetable garden?

- (A) $A = 10x - x^2$
 (B) $A = 10x - 2x^2$
 (C) $A = 20x - x^2$
 (D) $A = 20x - 2x^2$

$$L = 20 - 2x$$

$$A = LB$$

$$A = (20 - 2x) \times x$$

$$= 20x - 2x^2$$

6. What is the value of θ , to the nearest degree?

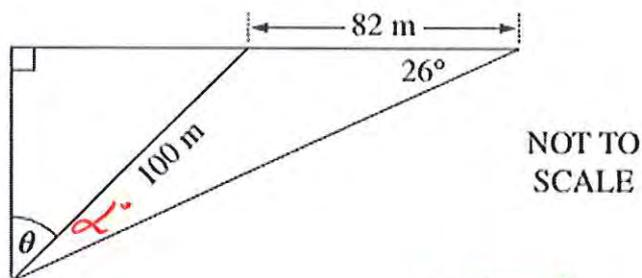

- (A) 21°
 (B) 32°
 (C) 43°
 (D) 55°

$$\frac{\sin \alpha^\circ}{82} = \frac{\sin 26^\circ}{100}$$

$$\sin \alpha = \frac{82 \times \sin 26^\circ}{100}$$

$$\alpha = 21^\circ$$

$$\theta = 64 - 21$$

$$= 43$$

7. A plane flies on a bearing of 30° from A to B ?

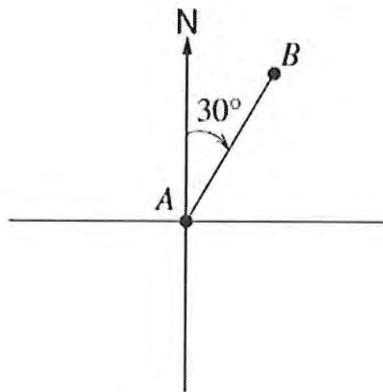

NOT TO SCALE

What is the bearing of A from B ?

- (A) 030°
 (B) 150°
 (C) 210°
 (D) 330°

Back bearing
 $30 + 180 = 210$

8. An entertainment system was purchased for \$2100 on 12 April 2014 using a credit card. Simple interest was charged at a rate of 19.74% per annum for purchases using the credit card. No other purchases were made and there was no interest-free period. The period for which interest was charged included the date of purchase and the date of payment.

What amount was required to pay the account in full on 20 May 2014?

- (A) \$2143.16
 (B) \$2143.59
 (C) \$2144.29
 (D) \$2144.74

$$I = \$2100 \times \frac{19.74\%}{365} \times 39$$

$$= \$44.29$$

$$\text{Total} = 44.29 + 2100$$

$$= \$2144.29$$

9. Jordan bought a new car for \$45 000. In the first year the value of the car depreciated by 25%. In the **second and third years** the value depreciated by 10% per year.

What is the value of the car at the end of the third year, to the nearest dollar?

- (A) \$17 663
 (B) \$24 750
 (C) \$27 000
 (D) \$27 338

$$S = 45000 \times 0.75 \times 0.9 \times 0.9$$

$$= \$27337.50$$

10. The equally spaced cross-sectional area of a water reservoir are shown.

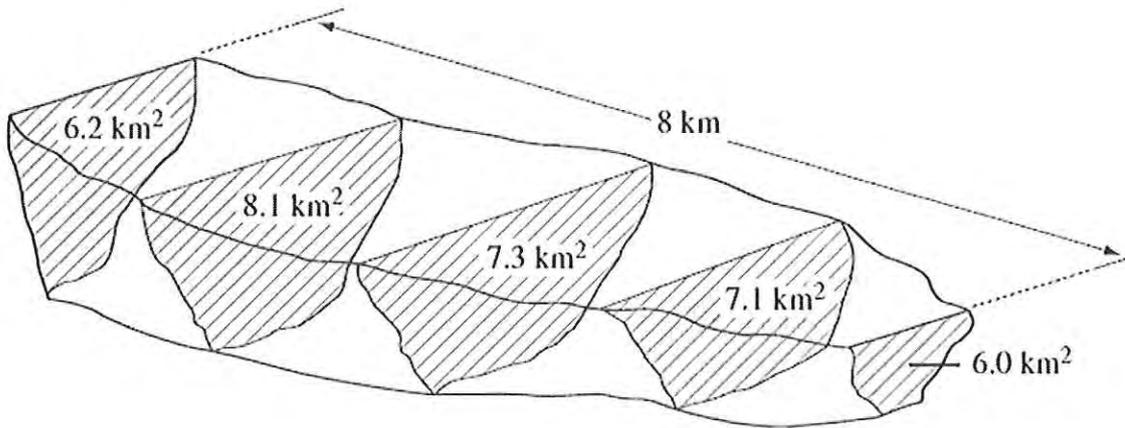

Using Simpson's rule twice, what is the approximate volume of the reservoir?

- (A) 31 km³
 (B) 58 km³
 (C) 117 km³
 (D) 234 km³
- Handwritten solution:*

$$V = \frac{h}{3}(A_1 + 4A_2 + A_3)$$

$$= \frac{2}{3}(6.2 + 4 \times 8.1 + 7.3)$$

$$+ \frac{2}{3}(7.3 + 4 \times 7.1 + 6.0)$$

$$= 58.4$$

11. Consider the data displayed in the stem-and-leaf plot below which shows the number of gold medals won by a country at each Olympic Games.

Stem Leaf	Key 1 5 = 15	<i>OH</i>	<i>NEW</i>
0 0 1 3 5 5 8		<i>Median = 10</i>	<i>Median = 11</i>
1 0 0 2 3 7 7 8		<i>IQR = 17 - 5</i>	<i>IQR = 17 - 5</i>
2 0 1		<i>= 12</i>	<i>= 12</i>

At the next Olympic Games the country wins 12 gold medals. When this is added to the data set:

- (A) The median will decrease and the interquartile range will decrease.
 (B) The median will decrease and the interquartile range will increase.
 (C) The median will increase and the interquartile range will remain the same.
 (D) The median will increase and the interquartile range will increase.

12. Max's phone has an 8 GB memory. He wants to download some apps that have an average size of 95 MB. The number of apps that Max is able to store on his phone is:

- (A) 11
 (B) 84
 (C) 86
 (D) 87
- $8\text{GB} = 8 \times 2^{10}$
 $= 8192\text{MB}$
 $\text{N}^\circ \text{ Apps} = \frac{8192}{95}$
 $= 86.23$

13. Benji is being trained as a drug sniffer dog to be used at the airport. To test Benji, 200 pieces of luggage are placed on a baggage carousel and drugs are placed in a small number of these. The results of Benji's test are shown in the two-way table below.

	Drugs detected	Drugs not detected	Total
Bags with drugs inside	23	2	25
Bags without drugs inside	19	156	175
Total	42	158	200

To be used as a drug sniffer dog, Benji must meet two criteria:

Criterion 1: The dog must have a minimum 90% success rate in detecting bags that have drugs inside

Criterion 2: The dog cannot have more than 15% 'false positives' ie saying drugs are in the luggage when in fact they are not.

Based on these criteria, which of the following statements is correct?

- (A) Benji passes both criteria.
 (B) Benji passes criterion 1 but fails criterion 2.
 (C) Benji fails criterion 1 but passes criterion 2.
 (D) Benji fails on both criteria.

success rate = $\frac{23}{25}$
 $= 92\%$ ✓

false positives = $\frac{19}{200}$
 $= 9.5\%$ ✓

14. David has bought his first car for \$4000. David does not think it is worth insuring the car but wants protection against damage to other people and property that he may be responsible for.

David will need to take out:

- (A) compulsory third party insurance
- (B) third party property insurance
- (C) comprehensive insurance
- (D) both A and B

15. A rock is thrown from the top of a 20-metre cliff. The height above the ground level after t seconds can be given by the equation $h = 20 + 15t - 5t^2$. The rock will hit the ground after:

- (A) 2 seconds
 - (B) 3 seconds
 - (C) 4 seconds
 - (D) 5 seconds
- $$h = 20 + 15 \times 5 - 5 \times 5^2$$
$$= -30$$
$$h = 20 + 15 \times 4 - 5 \times 4^2$$
$$= 0$$

16. The wattage on a toaster is 1750 W. The toaster is used for an average of 3 minutes per day. Given that electricity costs 25.1c/kWh, calculate the cost of running the toaster for a year.

- (A) \$4.58
 - (B) \$8.01
 - (C) 43.92
 - (D) \$127.24
- $$\text{Cost} = \frac{1.75 \times 3 \times 365}{60} \times \$0.251$$
$$= \$8.016$$

17. The profit made by a concert is given by the formula $P = 15N - 2000$, where P is the profit made and N is the number of people who attend the concert.

The profit will increase by how much if an extra 200 people attend the concert?

- (A) \$200
 - (B) \$1000
 - (C) \$3000
 - (D) \$5000
- $$200 \times 15 = \$3000$$

18. John and Mackenzie are on a fitness program for one month. The probability that John will finish the program successively is 0.7, while the probability that Mackenzie will finish it is 0.6. The probability tree diagram shows this information.

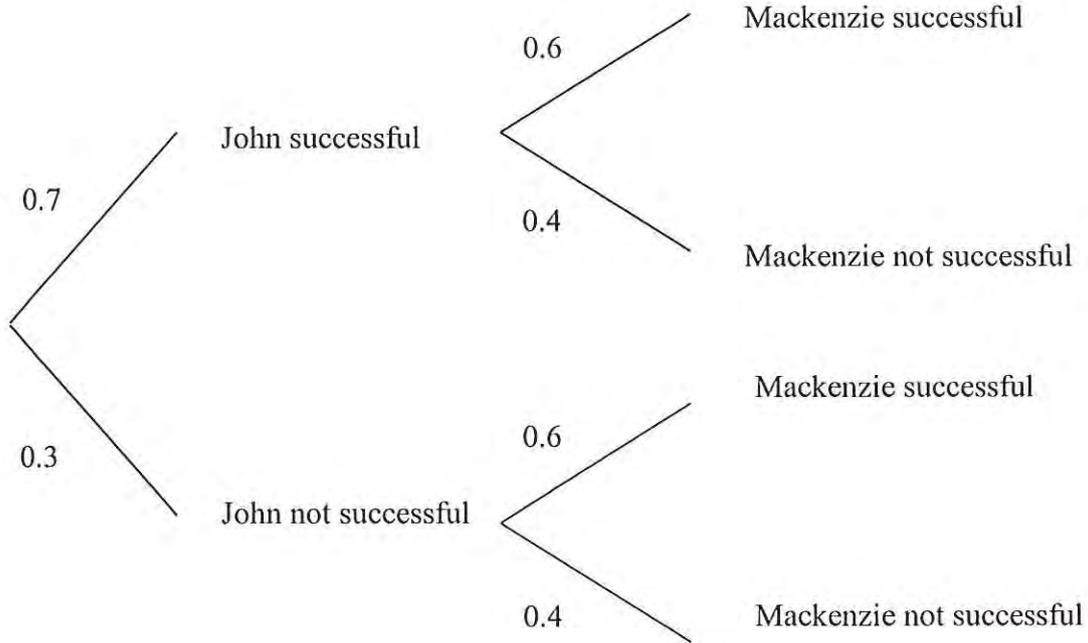

What is the probability that only one of John and Mackenzie will be successful?

- (A) 0.18
- (B) 0.28
- (C) 0.42
- (D) 0.46
- $(0.7 \times 0.4) + (0.3 \times 0.6) = 0.46$

19. A triangular pyramid and a triangular prism are of equal height, and have bases that are equal in area.

Which of the following statements is *correct*?

- (A) The triangular prism has three times the volume of the triangular pyramid.
- (B) The triangular prism has one-third the volume of the triangular pyramid.
- (C) Both the triangular pyramid and prism have the same volume
- (D) You cannot work out which has the greater volume without knowing the area of the bases and the heights.

20. Walter wants to invest money into an annuity for 5 years. He will invest \$1000 per year. Walter can invest the money at 8% p.a. with interest compounded quarterly, so he decides to make his contribution in four equal payments.

Use the table below to calculate the future value of Walter's annuity

Future value of \$1												
Period	Interest rate per period											
	1%	2%	3%	4%	5%	6%	7%	8%	9%	10%	11%	12%
1	1.0000	1.0000	1.0000	1.0000	1.0000	1.0000	1.0000	1.0000	1.0000	1.0000	1.0000	1.0000
2	2.0100	2.0200	2.0300	2.0400	2.0500	2.0600	2.0700	2.0800	2.0900	2.1000	2.1100	2.1200
3	3.0301	3.0604	3.0909	3.1216	3.1525	3.1836	3.2149	3.2464	3.2781	3.3100	3.3421	3.3744
4	4.0604	4.1216	4.1836	4.2465	4.3101	4.3746	4.4399	4.5061	4.5731	4.6410	4.7097	4.7793
5	5.1010	5.2040	5.3091	5.4163	5.5256	5.6371	5.7507	5.8666	5.9847	6.1051	6.2278	6.3528
6	6.1520	6.3081	6.4684	6.6330	6.8019	6.9753	7.1533	7.3359	7.5233	7.7156	7.9129	8.1152
7	7.2135	7.4343	7.6625	7.8983	8.1420	8.3938	8.6540	8.9228	9.2004	9.4872	9.7833	10.0890
8	8.2857	8.5830	8.8923	9.2142	9.5491	9.8975	10.2598	10.6366	11.0285	11.4359	11.8594	12.2997
9	9.3685	9.7546	10.1591	10.5828	11.0266	11.4913	11.9780	12.4876	13.0210	13.5795	14.1640	14.7757
10	10.4622	10.9497	11.4639	12.0061	12.5779	13.1808	13.8164	14.4866	15.1929	15.9374	16.7220	17.5487
11	11.5668	12.1687	12.8078	13.4864	14.2068	14.9716	15.7836	16.6455	17.5603	18.5312	19.5614	20.6546
12	12.6825	13.4121	14.1920	15.0258	15.9171	16.8699	17.8885	18.9771	20.1407	21.3843	22.7132	24.1331
13	13.8093	14.6803	15.6178	16.6268	17.7130	18.8821	20.1406	21.4953	22.9534	24.5227	26.2116	28.0291
14	14.9474	15.9739	17.0863	18.2919	19.5986	21.0151	22.5505	24.2149	26.0192	27.9750	30.0949	32.3926
15	16.0969	17.2934	18.5989	20.0236	21.5786	23.2760	25.1290	27.1521	29.3609	31.7725	34.4054	37.2797
16	17.2579	18.6393	20.1569	21.8245	23.6575	25.6725	27.8881	30.3243	33.0034	35.9497	39.1899	42.7533
17	18.4304	20.0121	21.7616	23.6975	25.8404	28.2129	30.8402	33.7502	36.9737	40.5447	44.5008	48.8837
18	19.6147	21.4123	23.4144	25.6454	28.1324	30.9057	33.9990	37.4502	41.3013	45.5992	50.3959	55.7497
19	20.8109	22.8406	25.1169	27.6712	30.5390	33.7600	37.3790	41.4463	46.0185	51.1591	56.9395	63.4397
20	22.0190	24.2974	26.8704	29.7781	33.0660	36.7856	40.9955	45.7620	51.1601	57.2750	64.2028	72.0524

$$n = 4 \times 5 = 20 \quad r = 8\% \div 2 = 4\%$$

$$P = \$250$$

$$FV = 250 \times 24.2974 = \$6074.35$$

- (A) \$5866.60
- (B) \$6074.35**
- (C) \$9549.10
- (D) \$24 297.40

21. Angus has a holiday job painting identification labels on parking areas in a shopping complex. Each label uses one of the letters A, B, C, D and E and one of the digits $6, 7, 8$ and 9 and he paints the codes in either red or blue.

How many different parking area labels can Angus paint?

- (A) 11
 (B) 20
 (C) 40
 (D) 90

$$5 \times 4 \times 2 = 40$$

22.

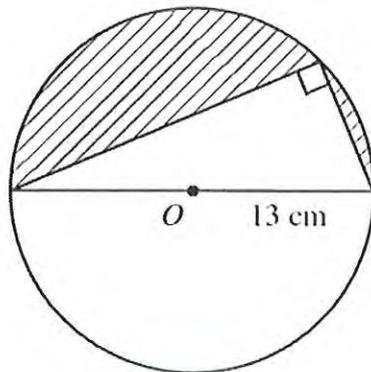

The centre of a circle is O and the radius is 13 cm. One side of the triangle is 10 cm long. Calculate the size of the shaded area correct to 1 decimal place.

- (A) 145.5 cm^2
 (B) 223.9 cm^2
 (C) 410.9 cm^2
 (D) 941.9 cm^2

$$\begin{aligned} x^2 + 10^2 &= 26^2 \\ x^2 &= 576 \\ x &= 24 \end{aligned}$$

$$\begin{aligned} A &= \frac{1}{2} \pi r^2 - \frac{1}{2} bh \\ &= \frac{1}{2} \pi \times 13^2 - \frac{1}{2} \times 24 \times 10 \\ &= 145.64 \end{aligned}$$

23. Lake Baikal in Siberia is one of the coldest places on Earth. Its typical winter temperature is -76°F . Use the formula $F = \frac{9}{5}C + 32$, where C = degrees Celsius and F = degrees Fahrenheit, to determine the typical winter temperature at Lake Baikal in degrees Celsius.

- (A) -24.4°C
 (B) -60°C
 (C) -104.8°C
 (D) -194.4°C

$$\begin{aligned} -76 &= \frac{9}{5}C + 32 \\ -108 &= \frac{9}{5}C \\ -540 &= 9C \\ C &= \frac{-540}{9} \\ &= -60^\circ \text{C} \end{aligned}$$

24. The table below shows Elijah's results in four subjects. The mean and standard deviation for each subject are also shown.

Subject	Elijah's Mark	Mean	Standard Deviation
English	70	60	7.5
Maths	72	60	10
Chemistry	71	63	4
Biology	68	58	8

1.3
1.2
2
1.25

In which subject did Elijah achieve his best standardised result?

- (A) English
(B) Maths
(C) Chemistry
(D) Biology

25.

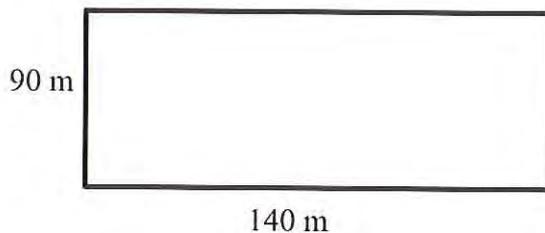

The diagram above shows the dimensions of a playing field. The lengths are given correct to the nearest 10 metres.

What is the maximum possible area of the playing field?

- (A) 12 600 m²
(B) 12 715.25 m²
(C) 13 775 m²
(D) 15 000 m²

$$\begin{aligned} \text{MAX AREA} &= 145 \times 95 \\ &= 13775 \end{aligned}$$

End of Section I

Section II

75 marks

Attempt Questions 26 – 30

Allow about 1 hour and 55 minutes for this section

Answer all questions in the spaces provided.

Your responses should include relevant mathematical reasoning and/or calculations

Extra writing space is provided on page 32. If you use this space, clearly indicate which question you are answering.

QUESTION 26 (15 marks) Answer the questions in the spaces provided

- (a) Sebastian weighs 80 kilograms. He has consumed 5 standard drinks in 2 hours. Calculate his blood alcohol level (BAC), correct to 2 significant figures.

$$\text{BAC male} = \frac{10N - 7.5H}{6.8x}$$
$$= \frac{10 \times 5 - 7.5 \times 2}{6.8 \times 80}$$

$$= 0.06433 \dots$$

\therefore BAC is 0.064 (2s.f.)

mark for significant figures

- (b) Timothy created this box and whisker plot from data that he had collected.

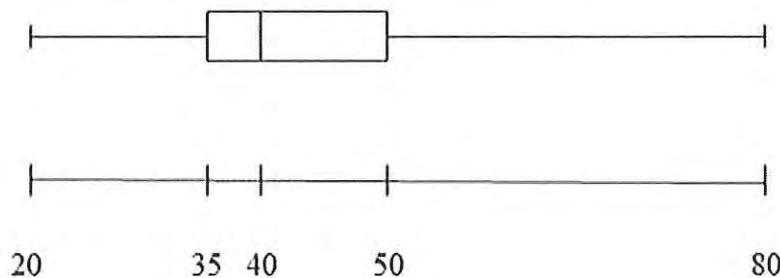

He said that the highest score was an outlier.

Is Timothy correct? Justify your answer with appropriate calculations.

$$\text{Outlier} = Q3 + 1.5 \times IQR$$
$$= 50 + 1.5 \times 15$$
$$= 72.5$$

\therefore 80 is an outlier

$IQR = 50 - 35 = 15$

Question 26 continued

- (c) The diagram show triangle ABE similar to triangle ACD in which $AE = x$, $ED = 2x$, $BE = 8$ cm and BE is parallel to CD .

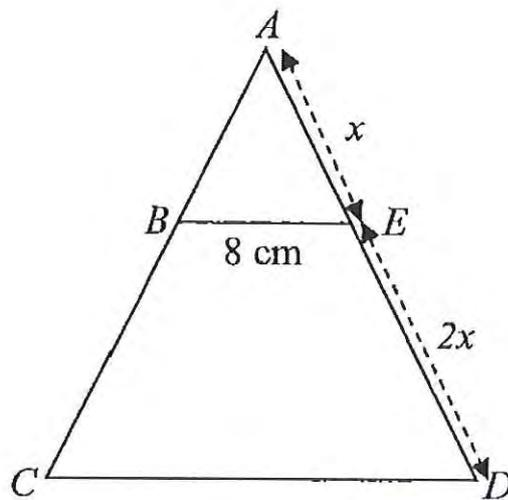

NOT TO SCALE

- (i) What is the ratio of enlargement from triangle ABE to triangle ACD ? 1

$$x : 3x = 1 : 3 \quad \text{or} \quad \frac{1}{3} \quad \checkmark$$

- (ii) What is the length of CD ? 1

$$CD = 8 \times 3 \\ = 24 \text{ cm} \quad \checkmark$$

- (iii) If $AD = 36$ cm, what is the length of ED ? 1

$$ED = \frac{2}{3} \times 36 \\ = 24 \text{ cm} \quad \checkmark$$

Question 26 continued

(d) According to Dominic's mobile phone plan, he is offered 2 gigabytes (GB) of data usage. After one year the phone company offers Dominic a 15% increase in his data usage, and after two years they offer him a further 10% increase in his usage.

(i) What is the overall percentage increase in Dominic's data usage after two years?

$$1 \times 1.15 \times 1.1 = 1.265 \quad \checkmark$$

$$1.265 - 1 = 0.265 \quad \checkmark$$

$$\text{Overall percentage} = \frac{0.265}{1} \times 100 \\ = 26.5\% \quad \checkmark$$

3

(ii) The original amount of data usage was calculated as 2.00 GB, correct to two decimal places. What is the percentage error in this calculation?

$$\text{error} = 0.005 \quad \checkmark$$

$$\text{Percentage Error} = \frac{0.005}{2.00} \times 100 \\ = 0.25\% \quad \checkmark$$

2

Question 26 continued on page 16

Question 26 continued

- (e) Mr Golightly needs to give his son some medicine. His son is 7 years old and weighs 26.25 kg. He is using the rule

$$D = \frac{kA}{70}$$

where D is the child's dosage and k is the weight of the child in kilograms and A is the adult dosage, to calculate the dose of medicine for his son. The adult dosage is 12 mL every morning and 12 mL every night. How many days will a 375 mL of medicine last for his son? 3

$$D = \frac{26.25 \times 24}{70} \quad \checkmark$$

$$= 9 \quad \checkmark$$

$$\begin{aligned} \text{N}^\circ \text{ of days} &= \frac{375}{9} \\ &= 41.6 \end{aligned}$$

$$\therefore 41 \text{ days} \quad \checkmark$$

End of Question 26

QUESTION 27 (15 marks) Answer the questions in the spaces provided.

- (a) Bellbirds live in rainforest area of NSW. The diagram shows the dimensions of one small pocket of rainforest, consisting of a triangle and an irregular shape.

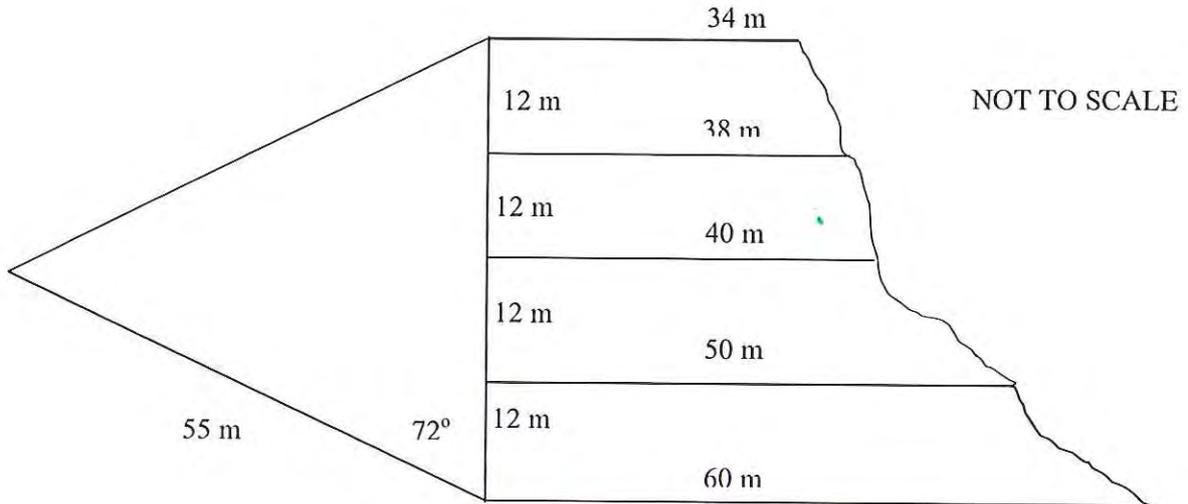

- (i) Use two applications of Simpson's Rule and the formula for the area of a triangle to determine the area of the rainforest.

4

$$\begin{aligned}
 A_1 &= \frac{1}{2} ab \sin C \\
 &= \frac{1}{2} \times 55 \times 48 \times \sin 72^\circ \\
 &= 1255.39 \dots \\
 A_2 &= \frac{h}{3} (d_f + 4d_m + d_L) \\
 &= \frac{12}{3} (34 + 4 \times 38 + 40) \\
 &\quad + \frac{12}{3} (40 + 4 \times 50 + 60) \\
 &= 2104 \\
 \therefore \text{Area} &= 1255.39 \dots + 2104 \\
 &= 3359.39 \\
 &= 3359 \text{ m}^2 \text{ (nearest m}^2\text{)}
 \end{aligned}$$

Question 27 continued on page 18

Question 27 continued

(a) (ii) The probability that a baby bellbird will survive to become an adult is 0.62. There are two baby bellbirds in a nest. What is the probably that

(1) they both survive to become adults?

1

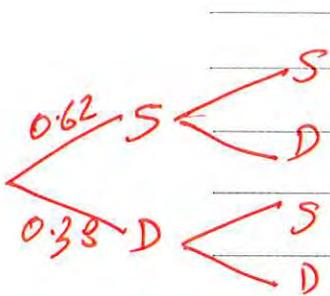

$$P(\text{both survive}) = 0.62 \times 0.62 = 0.3844$$



(2) only one survives to become an adult?

2

$$P(\text{only one survives}) = (0.62 \times 0.38) \times 2 = 0.4712$$

(3) at least one of the will survive to become an adult?

2

$$P(\text{at least one survives}) = 0.3844 + 0.4712 = 0.8556$$

Question 27 continued on page 19

Question 27 continued

(b) Solve the equation:

$$10x - 12 = \frac{5x}{4} + 9$$

3

$$4(10x - 12) = 5x + 36 \quad \checkmark$$

$$40x - 48 = 5x + 36 \quad \checkmark$$

$$35x = 84 \quad \checkmark$$

$$x = \frac{84}{35} = 2\frac{4}{5} \Rightarrow 2.4 \quad \checkmark$$

(c) The city of Bratislava in Slovakia is located at $(48^\circ N, 17^\circ E)$. Windhoek in Namibia lies on the same meridian of longitude and is 7930 km south of Bratislava.

Find the coordinates for the latitude and longitude of Windhoek.
You may assume the radius of the Earth to be 6 400 kilometres.

3

$$l = \frac{\theta}{360} \times 2\pi R$$

$$7930 = \frac{\theta}{360} \times 2\pi \times 6400 \quad \checkmark$$

$$7930 = \theta \times 111.70 \dots$$

$$\theta = 70.993 \quad \checkmark$$

$$= 71^\circ \text{ (nearest degree)}$$

$$\begin{array}{r} 71 \\ - 48 \\ \hline 23 \end{array}$$

$$\therefore \text{Windhoek. } (23^\circ S, 17^\circ E) \quad \checkmark$$

End of Question 27

QUESTION 28 (15 marks) Answer the questions in the spaces provided.

- (a) A class is on a treasure hunt as part of their Sports, Lifestyle & recreation course. They are given the following directions from base camp *A*. They are to walk on a bearing of 072° for 300 metres to point *B*. They are then to continue on a bearing of 156° for 400 metres to Point *C*. They then return to base camp *A*.

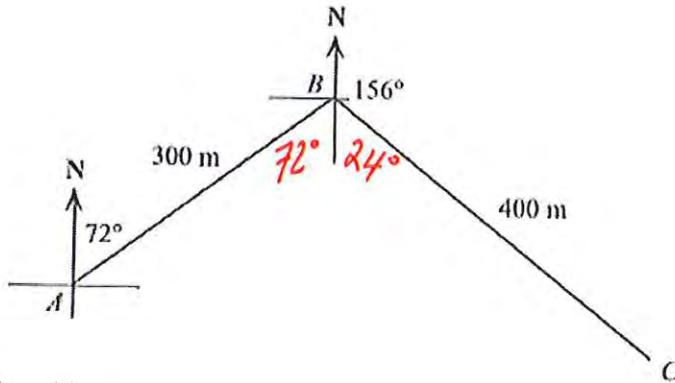

- (i) Show that angle $ABC = 96^\circ$.

1

$$\begin{aligned} \angle ABC &= 72 + 24 \quad \checkmark \\ &= 96^\circ \end{aligned}$$

- (ii) Calculate, AC , the distance that the class needs to travel on their final leg of their journey. Give your answer correct to the nearest metre.

2

$$\begin{aligned} a^2 &= c^2 + b^2 - 2cb \cos A \\ AC^2 &= 400^2 + 300^2 - 2 \times 400 \times 300 \times \cos 96^\circ \quad \checkmark \\ &= 275086.03... \\ AC &= \sqrt{275086.03...} \\ &= 524.487 \quad \checkmark \\ &= 524 \text{ m (nearest m)} \end{aligned}$$

Question 28 continued on page 21

Question 28 continued

- (a) (iii) Find the bearing that the class needs to take from Point C to return to base camp A. 2

$$\frac{\sin A}{a} = \frac{\sin B}{b}$$

$$\frac{\sin C}{300} = \frac{\sin 96^\circ}{524}$$

$$\sin C = \frac{300 \times \sin 96^\circ}{524}$$

$$\angle ACB = 35^\circ \quad \checkmark$$

$$\therefore \text{Bearing} = 360 - (35 + 24) \\ = 301^\circ \quad \checkmark$$

- (b) Under certain conditions, braking conditions of a vehicle can be calculated using the formula

$$d = \frac{V^2}{168}$$

where d is the braking distance in metres and V is the speed of the vehicle in kilometres per hour. George claims that if you double your speed then you double your braking distance.

Is George correct? Justify your answer with mathematical calculations. 2

$$d = \frac{V^2}{168}$$

$$d = \frac{(2V)^2}{168}$$

$$\text{if speed doubled } \rightarrow = \frac{4V^2}{168} \quad \checkmark$$

\therefore braking distance is quadrupled
So George is incorrect. ✓

Question 28 continued

- (c) When David's compass is near an electrical current, the needle points east of magnetic north at an angle θ .

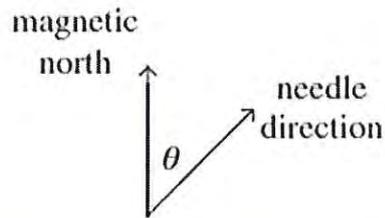

The size of θ is inversely proportional to the cube of the distance, x metres, between the compass and the electrical current.

- (i) Explain why the formula

$$\theta = \frac{k}{x^3}$$

represents the relationship between θ and x .

1

$$\theta \propto \frac{1}{x^3} \quad \checkmark$$
$$\theta = \frac{k}{x^3}$$

- (ii) When David's compass is 1.5 m from the electrical current, the size of θ is 5° . Determine the size of θ when $x = 50$ cm.

2

$$5 = \frac{k}{1.5^3}$$
$$k = 16.875 \quad \checkmark$$

$$\theta = \frac{16.875}{0.5^3}$$
$$= 135^\circ \quad \checkmark$$

Question 28 continued on page 23

Question 28 continued

- (d) During a flood, 2.4 hectares of land was covered by water to a depth of 25 cm.

How many kilolitres of water covered the land?

2

$$\begin{aligned} V &= 2.4 \times 10\,000 \times \frac{25}{100} \checkmark \\ &= 6000 \text{ m}^3 \\ &= 6000 \text{ kilolitres} \checkmark \end{aligned}$$

- (e) Peter buys a new car for \$39 900. He sells it 4 years later for \$20 875.

Calculate the rate of depreciation, r , on Peter's car using the declining balance method.
Give your answer correct to the nearest percent.

3

$$\begin{aligned} S &= V_0 (1 - r)^n \\ 20875 &= 39900 (1 - r)^4 \checkmark \\ \frac{20875}{39900} &= (1 - r)^4 \\ \sqrt[4]{0.523..} &= 1 - r \checkmark \\ 0.8504.. &= 1 - r \\ r &= 1 - 0.8504 \\ &= 0.1495 \checkmark \\ \text{rate} &= 15\% \text{ (nearest \%)} \end{aligned}$$

End of Question 28

QUESTION 29 (15 marks) Answer the questions in the spaces provided.

(a) The graph shows the tax payable against income, in thousands of dollars.

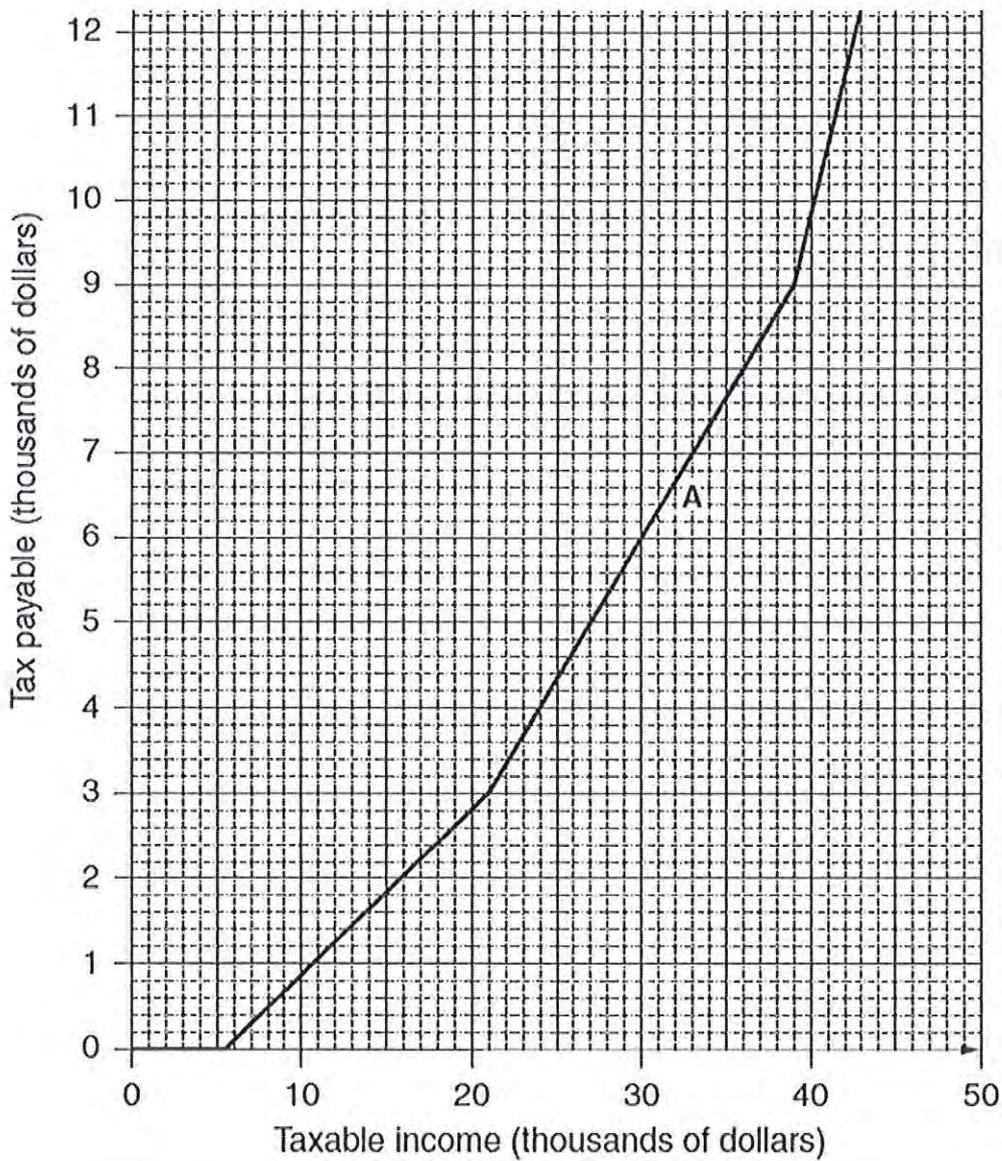

(i) Using the graph, find the tax payable on a taxable income of \$21 000. 1

tax payable = \$3000 ✓

(ii) Find the gradient of the section of the graph marked A. 1

$m = \frac{9-3}{39-21}$

$= \frac{6}{18}$

$= \frac{1}{3}$ ✓

Question 29 continued on page 25

Question 29 continued

- (iii) For taxable income between \$21 000 and \$39 000, how much of each dollar is payable in tax. 1

$$\frac{1}{3} \times \$1 = 33.3\text{¢}$$

accept 33¢ ✓

- (iv) Write an equation that could be used to calculate the tax payable T , in terms of the taxable income I , for taxable incomes between \$21 000 and \$39 000. 2

$$T = \frac{1}{3}I + b$$

$$3000 = \frac{1}{3} \times 21000 + b \quad \checkmark \quad \text{OR}$$

$$3000 = 7000 + b$$

$$b = -4000$$

$$\therefore T = \frac{1}{3}I - 4000 \quad \checkmark$$

$$T = \frac{1}{3}(I - 21000) + 3000 \quad \checkmark$$

$$= \frac{1}{3}I - 7000 + 3000$$

$$= \frac{1}{3}I - 4000 \quad \checkmark$$

Question 29 continued on page 26

Question 29 continued

- (b) The area (A) of a rectangular yard with a length of x metres is given by the formula: $A = 30x(15 - x)$ where A is in square metres. The graph of A against different values of x is shown below.

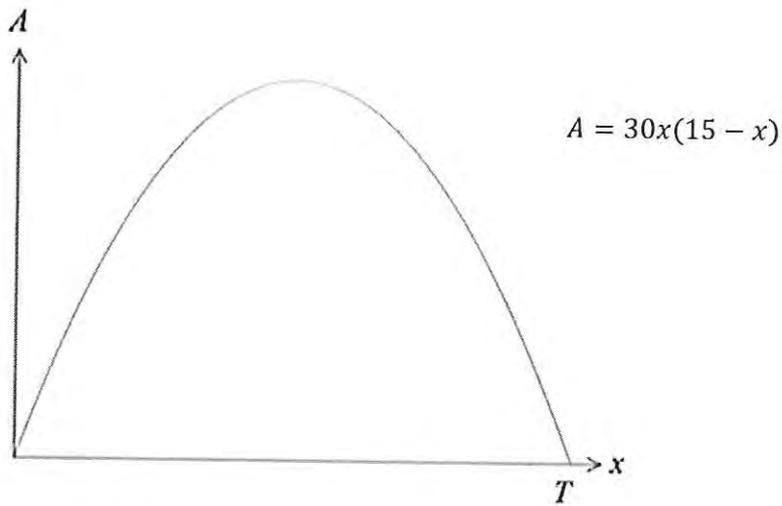

- (i) Complete the following table of values.

2

x	0	5	10	15
A	0	1500	1500	0

$$A = 30 \times 5(15 - 5) = 1500$$

$$A = 30 \times 10(15 - 10) = 1500$$

- (ii) What is the value of T on the graph?

1

$$T = 15$$

- (iii) Calculate the maximum area of the yard

2

$$\begin{aligned} \text{max area} &= 30(7.5)(15 - 7.5) \\ &= 1687.5 \text{ m}^2 \end{aligned}$$

Question 29 continued on page 27

Question 29 continued

(c) The time in Sydney is 10 hours ahead of the time in London. A jet leaves Sydney on Friday 8am and flies directly to London. The flight takes 22 hours.

(i) Calculate the time in London when the jet arrives? 2

$$\begin{aligned} \text{Time} &= \text{FRI 8am} - 10 + 22 \quad \checkmark \\ &= \text{FRI 8pm} \quad \checkmark \end{aligned}$$

(ii) If the distance between Sydney and London is 17 000 km, calculate the average speed of the jet in kilometres per hour. Give your answer to the nearest whole number. 1

$$\begin{aligned} S &= \frac{17000}{22} \\ &= 772.727 \dots \\ &= 773 \text{ km/h} \quad \checkmark \end{aligned}$$

(iii) The plane starts the flight with 184 tonnes of fuel, and on landing had enough fuel in reserve to fly another 45 minutes. How much fuel was used for the flight? Give your answer correct to the nearest tonne. 2

$$\begin{aligned} 184 &= 22.75x & 184 \times \frac{22}{22.75} \\ x &= \frac{184}{22.75} & \text{OR} & = 178 \text{ t} \\ &= 8.08 \text{ t/h} \quad \checkmark \end{aligned}$$

$$\begin{aligned} \text{fuel used} &= 8.08 \times 22 \\ &= 177.76 \\ &= 178 \text{ t} \quad \checkmark \\ &\text{(nearest tonne)} \end{aligned}$$

End of Question 29

QUESTION 30 (15 marks) Answer the questions in the spaces provided.

- (a) A game is designed using a spinner as shown in the diagram. Each game consists of one spin and the arrow points to the winning colour.

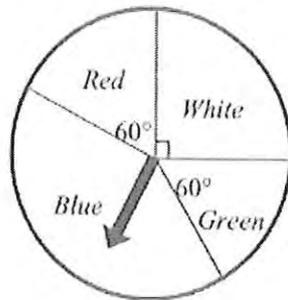

- (i) In any single game, what is the probability that the winning colour is blue? 2

$$\begin{aligned} \text{Angle} &= 360 - (2 \times 60 + 90) \\ &= 150^\circ \end{aligned}$$

$$\begin{aligned} P(\text{Blue}) &= \frac{150}{360} \\ &= \frac{5}{12} \quad \checkmark \quad \text{accept } \frac{15}{36} \end{aligned}$$

- (ii) If the arrow finishes on white, the player wins \$6. If it lands on red or green the player wins \$10. The player loses \$13 if the result of the spin is blue.

Calculate the financial expectation of one game. 2

$$\begin{aligned} \text{Fin. Expect}^n &= \frac{1}{4} \times \$6 + \frac{1}{3} \times \$10 - \frac{5}{12} \times \$13 \\ &= -0.583... \quad \checkmark \end{aligned}$$

\therefore financial expectation is to lose \$0.58 ✓

Question 30 continued

- (b) The table shows present value interest factors for some monthly interest rates (r) and loan terms in months (N)

Table of present value interest factors						
r	0.0060	0.0065	0.0070	0.0075	0.0080	0.0085
N						
45	39.33406	38.90738	38.48712	38.07318	37.66545	37.26383
46	40.09350	39.64965	39.21263	38.78231	38.35859	37.94133
47	40.84841	40.38714	39.93310	39.48617	39.04622	38.61311
48	41.59882	41.11986	40.64856	40.18478	39.72839	39.27924
49	42.34475	41.84785	41.35905	40.87820	40.40515	39.93975
50	43.08623	42.57113	42.06459	41.56645	41.07653	40.59470

Mark borrows \$10 000 for a car. He arranges to repay the loan with monthly repayments over 4 years. He is charged 7.2% per annum interest.

Using the table above, calculate the amount of interest Mark will pay over the term of this loan. 3

$$r = 7.2\% \div 12$$

$$= 0.6$$

$$\text{Repayment} = \frac{10000}{41.59882}$$

$$= \$240.39$$

$$n = 4 \times 12$$

$$= 48$$

$$\text{INTEREST} = 240.39 \times 48 - 10000$$

$$= \$1538.79$$

Question 30 continued on page 30

Question 30 continued

(c) The table shows a student's score on a game console and their pulse rate.

Game console (x)	5	7	18	20	30	43	50	58	60	65
Pulse rate (y)	97	93	85	77	75	64	70	64	60	55

(i) Draw a scatterplot and a line of best fit.

2

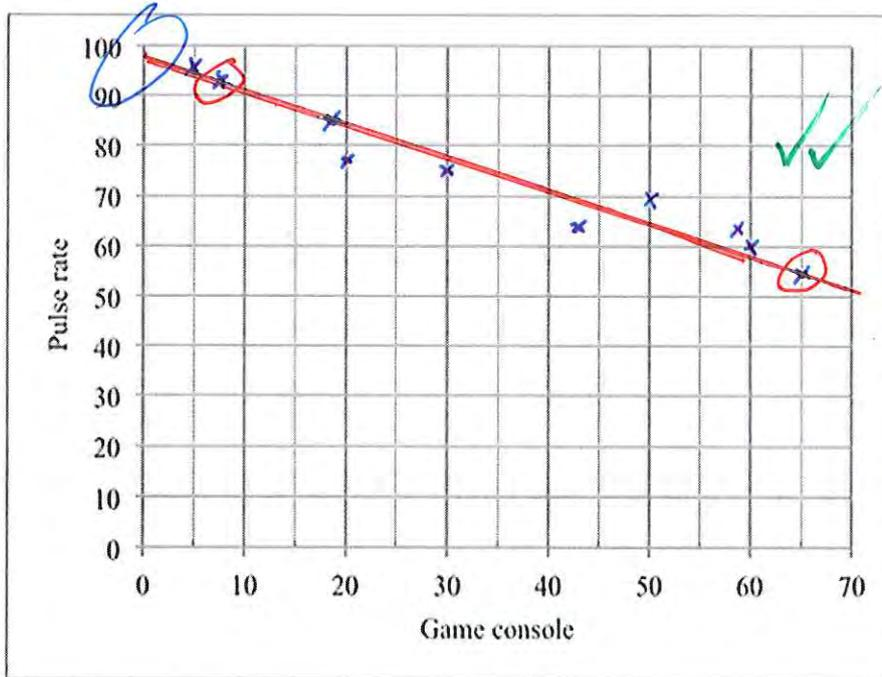

(ii) Determine an equation for the line of best fit.

2

$$\begin{aligned}
 m &= \frac{55 - 93}{65 - 7} \\
 &= -\frac{38}{58} \\
 &= -\frac{19}{29}
 \end{aligned}$$

$$y = -\frac{19}{29}x + 98$$

(iii) Calculate the value of the correlation coefficient. Answer correct to 2 decimal places.

1

from calculator

$$r = -0.9608$$

$$= -0.96 \text{ (2dp)}$$

Question 30 continued on page 31

Question 30 continued

(d) Solve these equations simultaneously, showing all working.

3

① $3x - 2y = 9$

② $4x + y = 23$ $\times 2$ ✓

$8x + 2y = 46$

$3x - 2y = 9$ +

$11x = 55$ ✓

$x = 5$

sub into ②

$4(5) + y = 23$

$20 + y = 23$ ✓

$y = 3$

End of paper

